

Kolečka & Nožky



- vysoce kvalitní nábytkové díly



DISTRIBUTOR

DVOJITÁ KOLEČKA

4-9



VIDLICOVÁ KOLEČKA TRANSPARENTNÍ

10



POSTELOVÁ KOLEČKA

11



KOLEČKA "FORCELLA" PRO SERVÍROVACÍ VOZÍKY

12



MOSAZNÁ KOLEČKA "BRARASCELLA"

13



VIDLICOVÁ KOLEČKA OCELOVÁ

14-18



PRŮMYSLOVÁ VIDLICOVÁ KOLEČKA

19



HLINÍKOVÉ NOŽKY

20-21



NOŽKY ZAMAK

22



OCELOVÉ NOŽKY

23-24



NASTAVITELNÉ KLUZÁKY

25



DVOJITÁ KOLEČKA / S MONTÁŽNÍ PLOTNIČKOU

Materiál: Kolečko: Nylon, černý
Plotnička: Ocel 2 mm, pozinkovaná

Použití: Montáž na plotničku 42 x 42 mm nebo 38 x 38 mm

S brzdou nebo bez brzdy

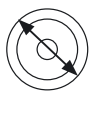

mm



mm

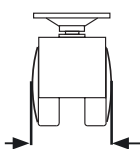

mm



kg

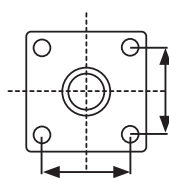

mm

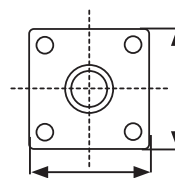

mm

08.04.003

30

43

32

15

27 x 27

38 x 38 x 2

08.04.029

40

56

41

25

32 x 32

42 x 42 x 2

08.04.097

50

64

47

30

32 x 32

42 x 42 x 2



mm



mm

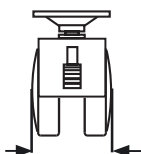

mm



kg

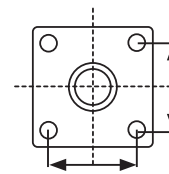

mm

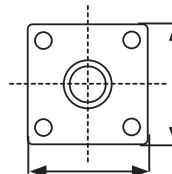

mm

08.04.028

40

56

41

25

32 x 32

42 x 42 x 2

08.04.096

50

64

47

30

32 x 32

42 x 42 x 2

DVOJITÁ KOLEČKA / UCHYCENÍ NA ČEP

Materiál: Kolečko: Nylon, černý
 Pouzdro na čep: Nylon, černý

Použití: Pouzdro Ø 12 x 12 mm
 (Není předmontováno)

S brzdou nebo bez brzdy



Bez brzdy



mm

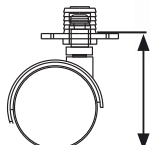

mm

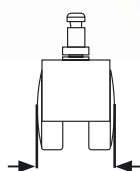

mm



kg



mm

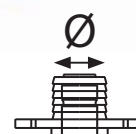

mm

08.04.001

30

43

32

15

12

12

08.04.016

40

56

38

25

12

12

08.04.087

50

64

47

30

12

12



S brzdou



mm

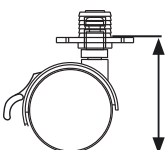

mm

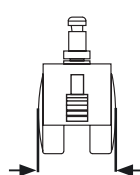

mm



kg



mm

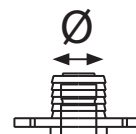

mm

08.04.014

40

56

41

25

12

12

08.04.086

50

64

47

30

12

12

DVOJITÁ KOLEČKA / SE ZÁVITEM

Materiál: Kolečko: Nylon, černý
Závit: Ocel, pozinkovaná

Použití: Dodávaný se závitem M8 a M10

S brzdou nebo bez brzdy



Bez brzdy



mm

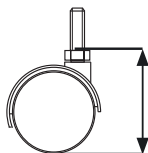

mm

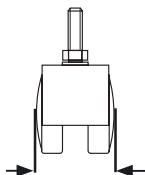

mm



kg

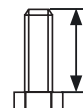

mm



M

# 08.04.031	40	49	37	25	12	8
# 08.04.105	50	60	45	30	15	8
# 08.04.116	50	60	45	30	15	10
# 08.04.119	50	60	45	30	20	10



S brzdou



mm

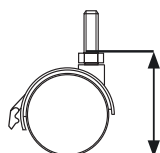

mm

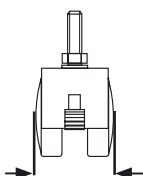

mm



kg



mm

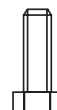

M

# 08.04.030	40	49	37	25	12	8
# 08.04.117	50	60	45	30	15	8
# 08.04.118	50	60	45	30	15	10
# 08.04.121	50	60	45	30	20	10

DVOJITÁ KOLEČKA / UCHYCENÍ NA ČEP



Materiál: Kolečko: Nylon, černý
 Pouzdro na čep: Nylon, černý

Použití: Pouzdro Ø 10,5 x 30 mm
 (Není předmontováno)

Hloubka vrtání 33 mm

S brzdou nebo bez brzdy



mm

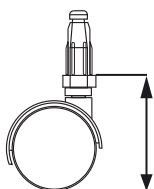

mm



mm



kg



mm

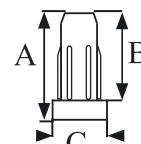

mm

Bez brzdy

08.04.015

40

53

38

25

10,5

A

B

C

33

30

15,5

08.04.017

50

65

47

30

10,5

33

30

15,5



mm

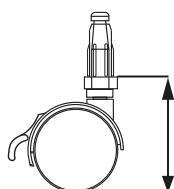

mm

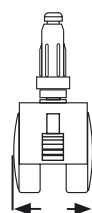

mm



kg



mm

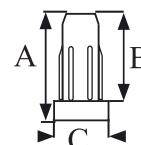

mm

S brzdou

08.04.013

40

53

38

25

10,5

A

B

C

33

30

15,5

08.04.018

50

65

47

30

10,5

33

30

15,5

DVOJITÁ KOLEČKA / UCHYCENÍ NA "U" PROFIL

Materiál: Kolečko: Nylon, černý
 "U" profil: Ocel, černě pozinkovaná

Použití: Dodávaný s "U" profilem širokým 16 mm nebo 19 mm a M 4 x 22 mm šroubem.

S brzdou nebo bez brzdy



Bez brzdy



mm

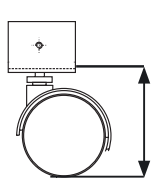

mm

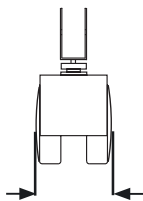

mm



kg



mm

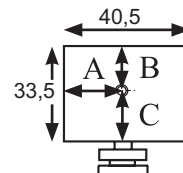

mm

08.04.032
 # 08.04.036

40
 40

56
 56

41
 41

25
 25

16
 19

mm		
A	B	C
20,25	7,5	26
20,25	7,5	26



S brzdou



mm

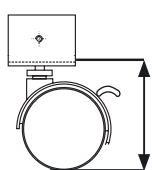

mm

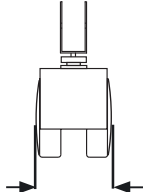

mm



kg



mm

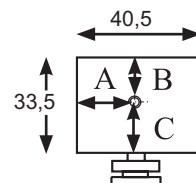

mm

08.04.033
 # 08.04.037

40
 40

56
 56

41
 41

25
 25

16
 19

mm		
A	B	C
20,25	7,5	26
20,25	7,5	26

DVOJITÁ KOLEČKA / KOLEČKA Z ŠEDÉ GUMY

Materiál:	Tělo kolečka:	Nylon, černý
	Povrch kolečka:	Měkká guma, šedá
	Plotnička:	Ocel 2mm, pozinkovaná
Použití:	Montáž na ocelovou plotničku 42 x 42 mm.	
	S brzdou nebo bez brzdy	

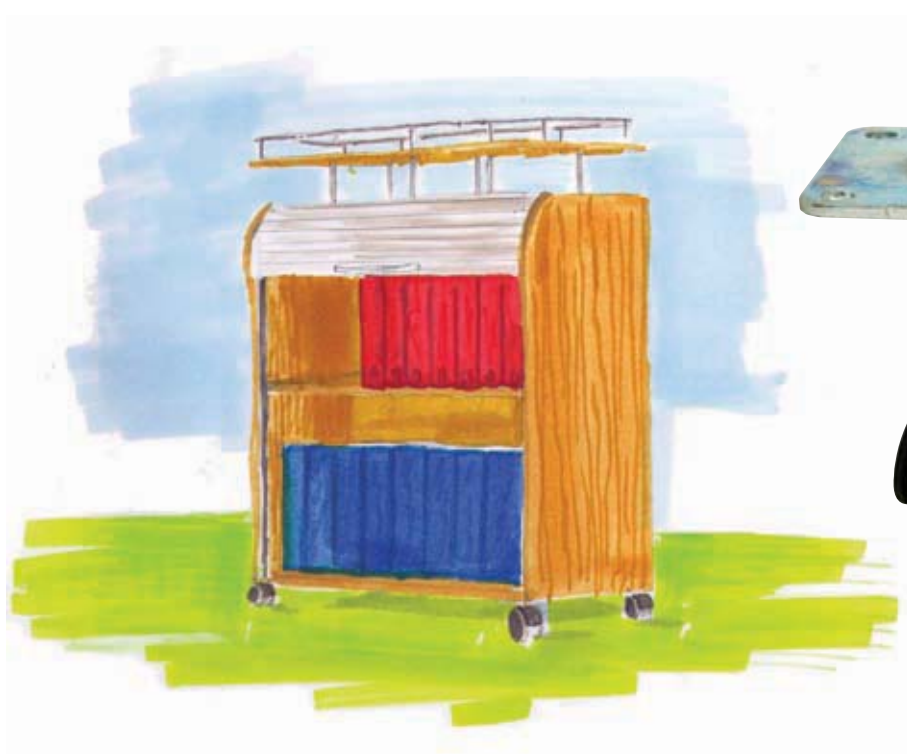

mm

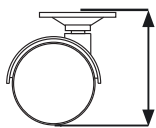

mm

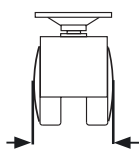

mm



kg

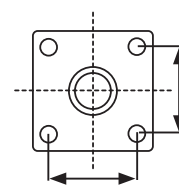

mm

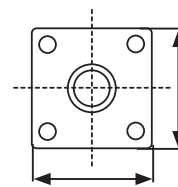

mm

08.04.098

50

68

55

30

32 x 32

42 x 42 x 2

VIDLICOVÁ KOLEČKA / TRANSPARENTNÍ

Materiál: Tělo kolečka: PU, čirý
Povrch kolečka: PU, čirý
Kovové části: Ocel 1,5 mm a 1,8 mm,
pochromovaná

Použití: Dodávaná s montážní plotničkou 42 x 42 mm
a 50 x 50 mm
S plastovou brzdou nebo bez brzdy

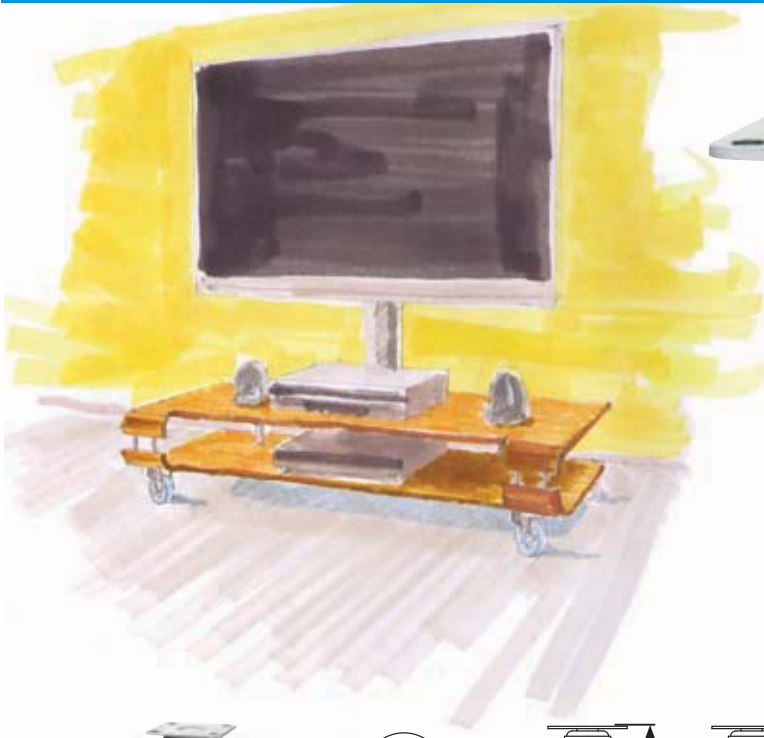

Bez brzdy



mm



mm

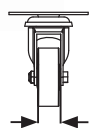

mm



kg

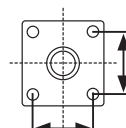

mm

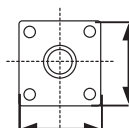

mm



S brzdou



mm

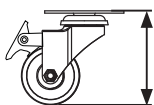

mm

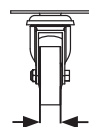

mm



kg

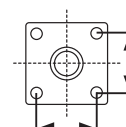

mm

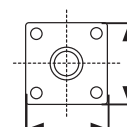

mm

08.12.300

50

65

20

50

32 x 32

42 x 42 x 1,5

08.12.310

75

90

23

70

36 x 36

50 x 50 x 1,8

08.12.301

50

65

20

50

32 x 32

42 x 42 x 1,5

08.12.311

75

90

23

70

36 x 36

50 x 50 x 1,8

POSTELOVÁ KOLEČKA

Materiál:	Kolečko:	Nylon, černý nebo bílý
	Profil:	Ocel, pozinkovaná
Použití:	Montážní konzola:	19 x 42 mm (A, B)
	Vzdálenost děr:	32 mm (C.C)



Barva kolečka



mm

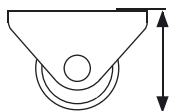

mm



mm



kg

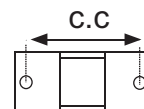

mm

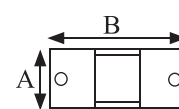

mm

#	Barva kolečka	mm	mm	mm	kg	mm	A B
# 08.06.010	Bílá	25	28	13	25	32	19/42
# 08.06.027	Černá	25	28,6	13	25	32	19/42
# 08.06.020	Bílá	29	30	13	25	32	19/42
# 08.06.025	Bílá	29	32	13	25	32	19/42

KOLEČKA NA JÍDELNÍ VOZÍKY "FORCELLA"

Materiál: Profil: Bronz nebo
Poniklovaná ocel
Kolečko: Nylon, černý

Použití: Ocelový čep Ø 7 x 35 mm s černým
plastovým pouzdem.



Povrch



mm

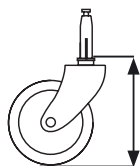

mm



mm



kg



mm

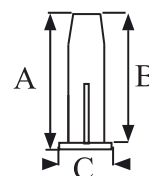

mm

#	Povrch	mm	mm	mm	kg	mm	mm		
							A	B	C
# 08.01.085	Bronz	38	46	8	9	10	30	17	28
# 08.01.110	Nikl	75	86	11	15	10	30	17	28

MOSAZNÁ KOLEČKA "BRASSELLA"

Materiál: Leštěná mosaz

Použití: Montáž s použitím ocelového šroubu
F-593 12.09.890-0 a M8
Prodáváný zvlášť

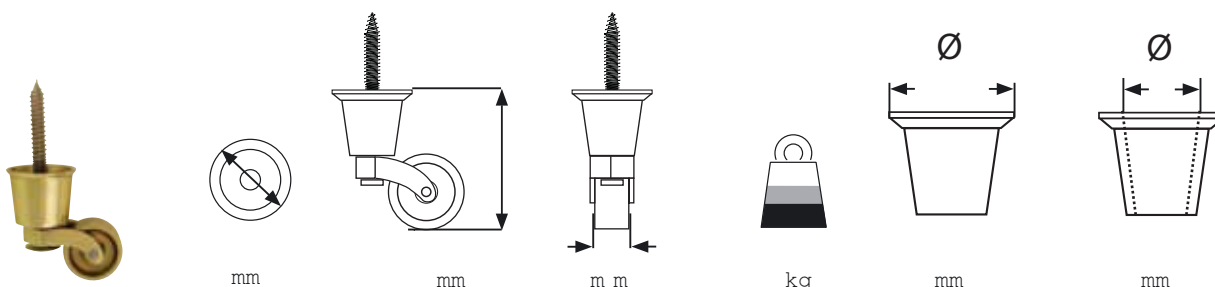
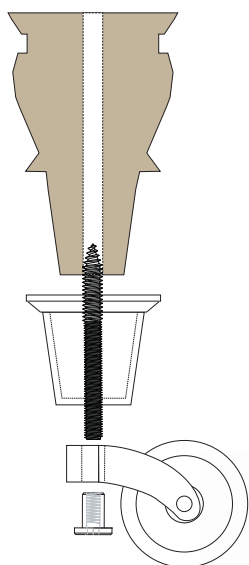

08.05.221

32

65

19

50

39

31,5

VIDLICOVÁ KOLEČKA OCELOVÁ / S MONTÁŽNÍ PLOTNIČKOU

Materiál: Kolečko: Měkká šedá guma
Ocelové části: Ocel, pozinkovaná

Použití: Montáž na horní plotničku
S brzdou nebo bez brzdy



Kolečko bez brzdy



Kolečko s brzdou



Bez brzdy



mm

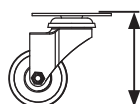

mm

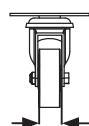

mm



kg

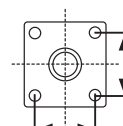

mm

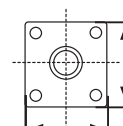

mm



S brzdou



mm

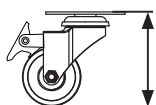

mm

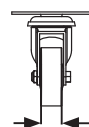

mm



kg

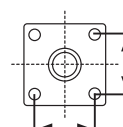

mm

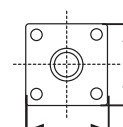

mm

08.12.161

50

72

16

50

35 x 35

50 x 50 x 1,5

08.12.163

75

104

21

70

45 x 45

65 x 65 x 2

08.12.162

50

72

16

50

35 x 35

50 x 50 x 1,5

08.12.164

75

104

21

70

45 x 45

65 x 65 x 2



VIDLICOVÁ KOLEČKA OCELOVÁ / MONTÁŽNÍ PLOTNIČKA + CELKOVÁ BRZDA

Materiál: Kolečko: Šedá měkká guma
Kovové části: Ocel, pozinkovaná

Použití: Montáž na horní plotničku

S celkovou brzdou, která zabraňuje
pojízdnosti i otáčení.

Kolečko s celkovou brzdou



S brzdou



mm

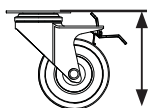

mm

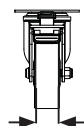

mm



kg

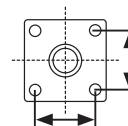

mm

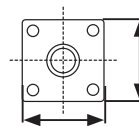

mm

08.12.167

75

104

21

70

45 x 45

65 x 65 x 2

Brzdňý systém v praxi

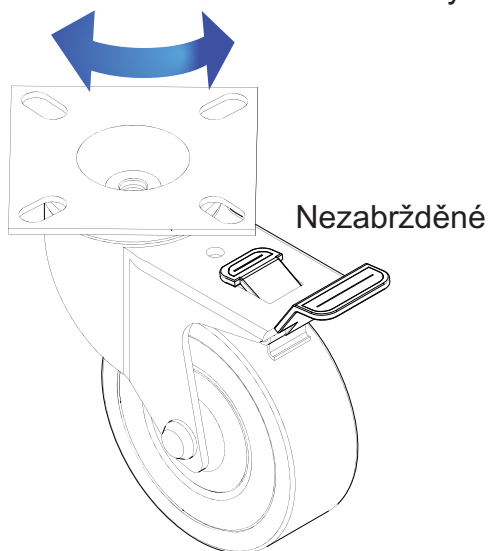

Nezabržděné

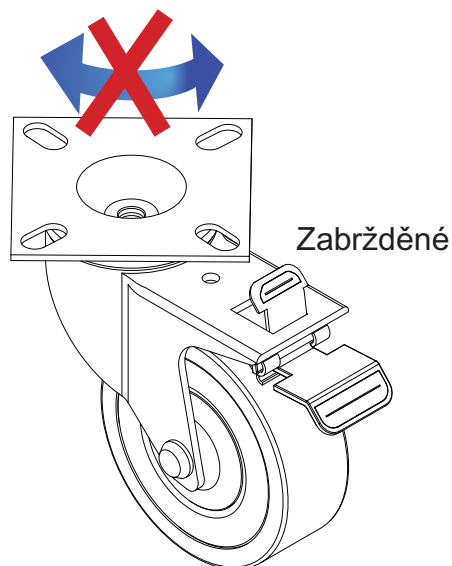
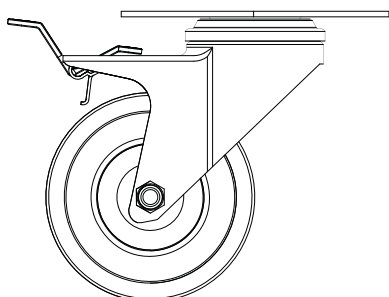

Zabržděné

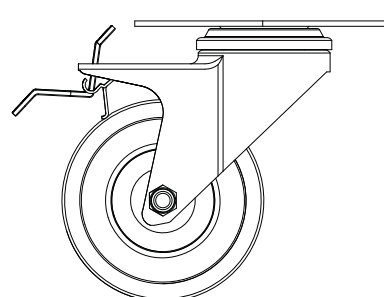

VIDLICOVÁ KOLEČKA OCELOVÁ / SE ZÁVITEM

Materiál: Kolečko: Šedá měkká guma
 Kovové části: Ocel, pozinkovaná
 Použití: Zabudovaný závit M10 x 30 mm
 S brzdou nebo bez brzdy



Kolečko bez brzdy



Kolečko s brzdou



Bez brzdy



mm

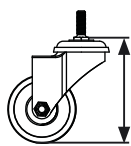

mm

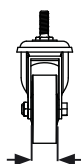

mm



kg



M



mm

08.12.165

75

72

21

70

M10

30



S brzdou



mm

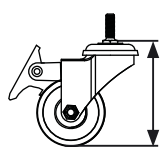

mm

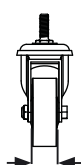

mm



kg



M



mm

08.12.166

75

72

21

70

M10

30

VIDLICOVÁ KOLEČKA OCELOVÁ / S OTVOREM PRO ŠROUB



Materiál: Kolečko: Šedá měkká guma
Kovové části: Ocel, pozinkovaná

Použití: Otvor pro maticový šroub
S brzdou nebo bez brzdy



Kolečko bez brzdy



Kolečko s brzdou



Bez brzdy



mm

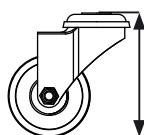

mm

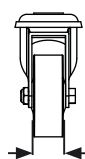

mm



kg

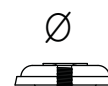

mm

08.12.168

50

70

16

50

10,5

08.12.170

75

102

21

70

10,5

08.12.205

100

132

25

80

12,5



S brzdou



mm

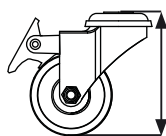

mm

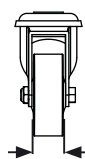

mm



kg

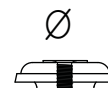

mm

08.12.169

50

70

16

50

10,5

08.12.171

75

102

21

70

10,5

08.12.206

100

132

25

80

12,5

VIDLICOVÁ KOLEČKA OCELOVÁ / VESTAVĚNÁ PLOTNIČKA

Materiál: Kolečko: Šedá měkká guma
Kovové části: Ocel 1,5 mm, pozinkovaná

Použití: Montáž na horní pevnou plotničku
Bez brzdy

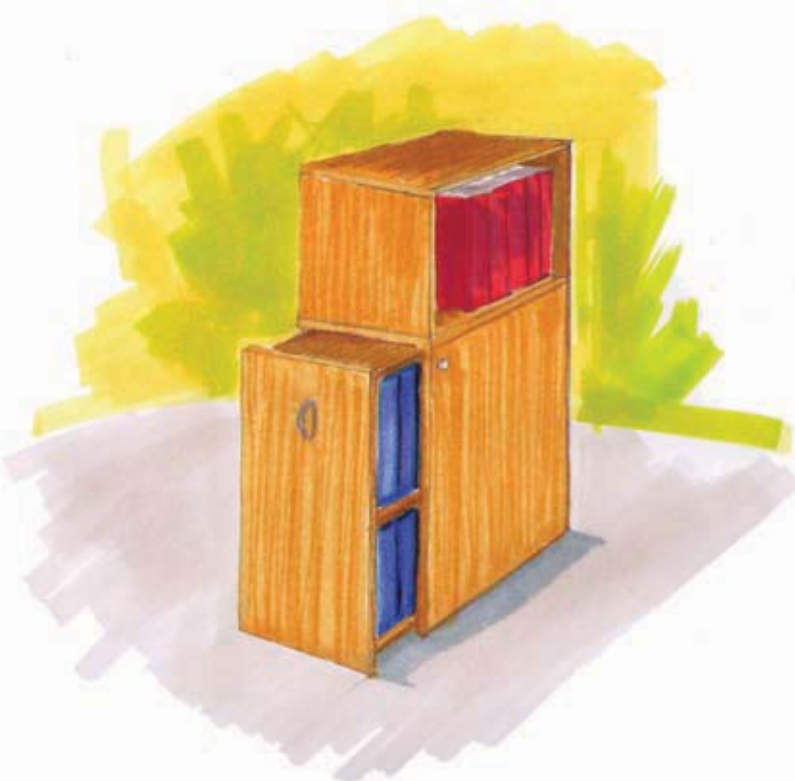

mm

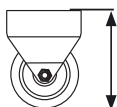

mm

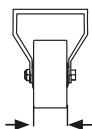

mm



kg

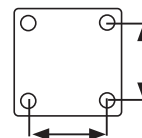

mm

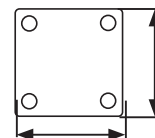

mm

08.12.150

50

67

20

50

30 x 30

45 x 45 x 1,5

**PRŮMYSLOVÁ VIDLICOVÁ KOLEČKA /
S HORNÍ PLOTNIČKOU**

Materiál: Kolečko: Šedá guma
Kovové části: Ocel 4 mm, pozinkovaná

Použití: Horní plotnička
Bez brzdy nebo s celkovou brzdou, která zabraňuje jak poježdění, tak otáčení

Pozor: Dodáváno nesmontované



Bez brzdy



mm

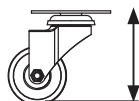

mm

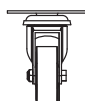

mm



kg

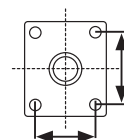

mm

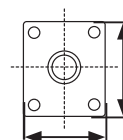

mm

08.12.210

160

170

40

150

80 x 105

110 x 135 x 4

08.12.215

200

218

40

230

80 x 105

110 x 135 x 4



S brzdou



mm



mm

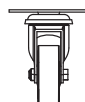

mm



kg

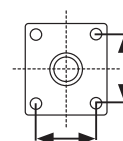

mm

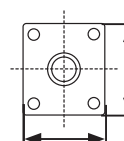

mm

08.12.211

160

170

40

150

80 x 105

110 x 135 x 4

08.12.216

200

218

40

230

80 x 105

110 x 135 x 4

HLINÍKOVÉ NOŽKY "JACO" / S HORNÍ PLOTNIČKOU

Materiál: Trubka: Hliník, Stříbrný lak
Okraje a dekor: Plast, černý
Plotnička: Ocel 2 mm, pozinkovaná

Použití: S předmontovanou horní plotničkou 39 x 39 mm nebo 42 x 42 mm



mm

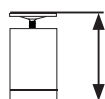

mm

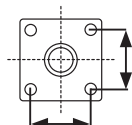

mm

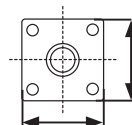

mm

# 06.09.465	40	50	29 x 29	39 x 39 x 2
# 06.09.466	40	100	29 x 29	39 x 39 x 2
# 06.09.467	40	150	29 x 29	39 x 39 x 2
# 06.09.475	60	50	32 x 32	42 x 42 x 2
# 06.09.476	60	100	32 x 32	42 x 42 x 2
# 06.09.477	60	150	32 x 32	42 x 42 x 2

HLINÍKOVÉ NOŽKY "NIKO" / S HORNÍ PLOTNIČKOU

Materiál: Trubka: Hliník, Stříbrný lak
Okraje a dekor: Plast, černý
Plotnička: Ocel 2 mm, pozinkovaná

Použití: S předmontovanou horní plotničkou 39 x 39 mm nebo 42 x 42 mm



mm

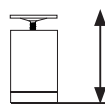

mm

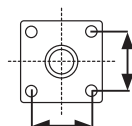

mm

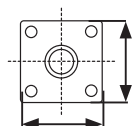

mm

# 06.09.455	40 x 40	50	29 x 29	39 x 39 x 2
# 06.09.456	40 x 40	100	29 x 29	39 x 39 x 2
# 06.09.457	40 x 40	150	29 x 29	39 x 39 x 2
# 06.09.471	60 x 60	50	32 x 32	42 x 42 x 2
# 06.09.472	60 x 60	100	32 x 32	42 x 42 x 2
# 06.09.473	60 x 60	150	32 x 32	42 x 42 x 2



HLINÍKOVÉ NOŽKY "TRIA" / S MONTÁŽNÍ PLOTNIČKOU

Materiál: Trubka: Hliník, Stříbrný lak
 Okraje a dekor: Plast, černý
 Plotnička: Ocel 2 mm, pozinkovaná

Použití: Zabudovaná horní plotnička 39 x 39 mm

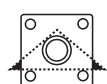

mm

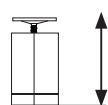

mm

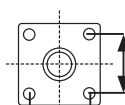

mm

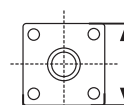

mm

# 06.09.468	40 x 40 x 55	50	29 x 29	39 x 39 x 2
# 06.09.469	40 x 40 x 55	100	29 x 29	39 x 39 x 2
# 06.09.470	40 x 40 x 55	150	29 x 29	39 x 39 x 2



HLINÍKOVÁ NOŽKA "DOLLY" / NASTAVITELNÁ PLOTNIČKA

Materiál: Trubka: Anodizovaný hliník
 Okraj, plotnička: Plast, šedý

Použití: S kulatou nastavitelnou montážní plotničkou, průměr 59 mm. Výškově nastavitelná o 30 mm.



Povrch

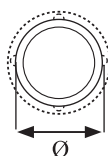

Ø

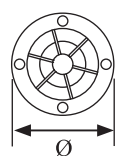

Ø

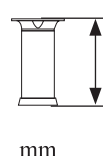

mm

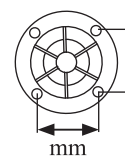

mm

# 06.09.500	Anodizovaný	40	59	100 - 130	34 x 34
-------------	-------------	----	----	-----------	---------

NOŽKY ZAMAK "DANUTA" / NASTAVITELNÝ KLUZÁK

Materiál: Noha: Zamak, Chrom, Nikl-satin
nebo Chrom satin

Kluzák: Zamak a černý plast

Použití: Se zabudovanou plotničkou 40 x 40 mm.
Výškově nastavitelný kluzák o 10 mm.



Povrch

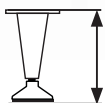

mm

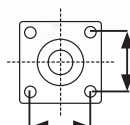

mm

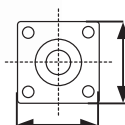

mm

# 06.09.365	Nikl-satin	50 - 60	30 x 30	40 x 40 x 2
# 06.09.366	Chrom	50 - 60	30 x 30	40 x 40 x 2
# 06.09.367	Chrom satin	50 - 60	30 x 30	40 x 40 x 2
# 06.09.370	Nikl-satin	80 - 90	30 x 30	40 x 40 x 2
# 06.09.371	Chrom	80 - 90	30 x 30	40 x 40 x 2
# 06.09.372	Chrom satin	100 - 110	30 x 30	40 x 40 x 2
# 06.09.375	Nikl-satin	100 - 110	30 x 30	40 x 40 x 2
# 06.09.376	Chrom	100 - 110	30 x 30	40 x 40 x 2
# 06.09.377	Chrom satin	100 - 110	30 x 30	40 x 40 x 2

OCELOVÁ NOŽKA "ADRIA" SE ZÁVITEM

Materiál: Noha: Ocel, Stříbrný lak
Podstava: Plast, černý

Použití: Se závitem M8 x 25 mm



Povrch

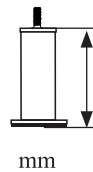
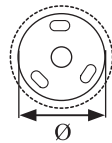

06.09.440

Stříbrný lak

35

130

55

M8

25

OCELOVÁ NOHA "JIM" / S MONTÁŽNÍ PLOTNIČKOU

Materiál: Noha: Ocel, Chrom
Podstava: Plast, černý

Použití: S montážní plotničkou 58 x 77 mm



Povrch

průměr
nohy

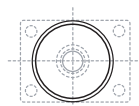

mm

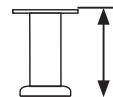

mm

průměr
základny



mm

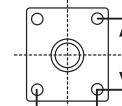

mm

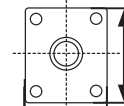

mm

06.12.027

Chrom

50

50

87

44 x 63

58 x 77 x 1,5

06.12.025

Chrom

50

150

73

44 x 63

58 x 77 x 1,5

OCELOVÉ NOŽKY "SOFI" A "PETER" /
NASTAVITELNÝ KLUZÁK

Peter *



Materiál: Noha: Ocel, Chrom
Kluzák: Ocel, Chrom a Plast, černý
Použití: S výškově nastavitelným kluzákem o 5 mm

Sofi *



Model

Povrch

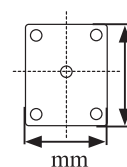
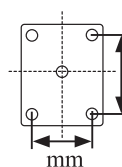
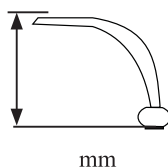

# 06.12.015	"Sofi"	Chrom	110 - 115	30 x 51	53 x 87 x 2
# 06.12.010	"Peter"	Chrom	115 - 120	30 x 51	53 x 87 x 2

OCELOVÉ NOŽKY "ANDY" /
NASTAVITELNÝ KLUZÁK



Materiál: Noha: Ocel, Chrom
Podstava: Plast, černý
Použití: Se zabudovanou plotničkou 61 x 61 mm
Výškově nastavitelná o 10 mm



Povrch

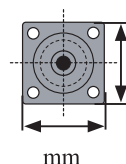
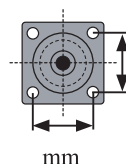
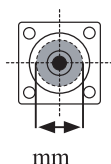

24	# 06.09.460	Chrom	30	100 - 110	46 x 46	61 x 61 x 2
----	-------------	-------	----	-----------	---------	-------------

JUMBO KLUZÁKY / S MONTÁŽNÍ PLOTNIČKOU



7055

6363

Materiál: Tělo: Plast, Chrom
Kluzák: Plast, černý

Použití: Montážní plotnička 38 x 38 mm a 42 x 42 mm



6747

5746

Model

Povrch



Ø



mm

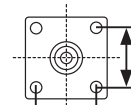

mm

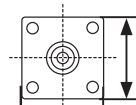

mm

	Model	Povrch	Ø	mm	mm	mm	mm
# 09.01.063	# 5746	Chrom	55	48	26 x 26	38 x 38 x 1,5	
# 09.01.065	# 6747	Chrom	68	44	26 x 26	38 x 38 x 1,5	
# 09.01.066	# 6363	Chrom	63	62	32 x 32	42 x 42 x 2	
# 09.01.067	# 7055	Chrom	70	54	32 x 32	42 x 42 x 2	

NASTAVITELNÝ KLUZÁK



Materiál: Plast, černý

Použití: Průměr vrtání 10 mm
Nastavitelný kluzák

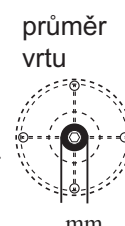
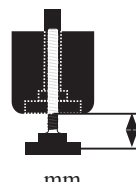

# 10.16.410	50	25	26 - 36	10 x 13
# 10.16.415	50	25	43 - 53	10 x 13



- vysoce kvalitní nábytkové díly